

AUTOMATED BUTTERFLY VALVES WITH **BELIMO** ACTUATORS

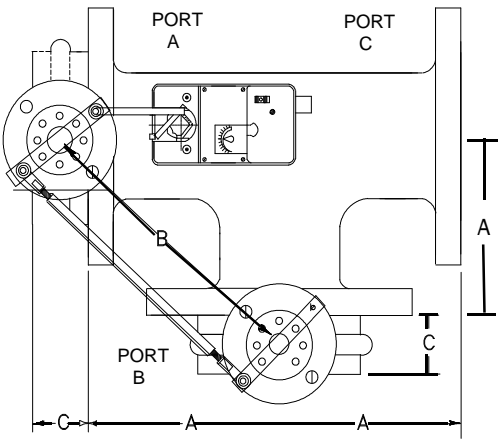

System pressure is normally not a resistance factor For 3-way valve disc closure.

ACTUATOR PART # * = DUAL ACTUATORS	SIZE	A DIM.	B DIM.	C DIM.	Cv	Max. Close Rating	Bubble Leak Occur.
AMB, AFB SERIES	2	4.5	7 1/2	1 5/8	84	125	125#
AMB, AFB SERIES	2.5	5.0	8 1/4	1 3/4	163	125	125#
AMB, AFB SERIES	3	5.5	9 3/16	1 3/4	267	110	125#
AMB, AFB SERIES	4	6.5	10 3/4	2.0	496	110	50#
AMB, AFB SERIES	5	7.5	12 1/4	2 1/8	775	95	50#
AMB, AFB SERIES	6	8.0	13 15/16	2 1/8	1025	85	50#
GMB, EFB SERIES	8	9.0	14 7/8	2 1/2	1862	85	50#
GMB, EFB SERIES	10	11	17 3/4	2 1/2	2948	75	50#
GMB, EFB SERIES	12	12	19 3/4	3.0	4393	60	50#
*GMB or *EFB	14	14	21 3/4	3.0	5939	80	50#
*GMB or *EFB	16	15	24 3/4	4.0	7867	70	50#

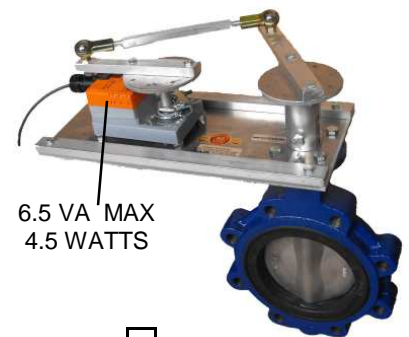
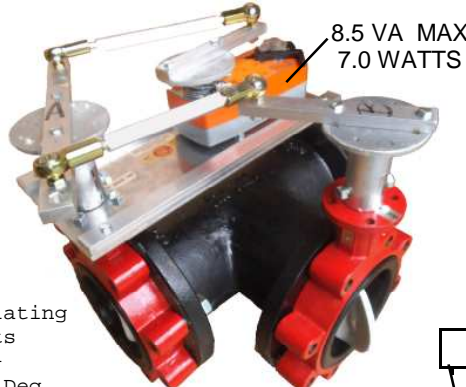
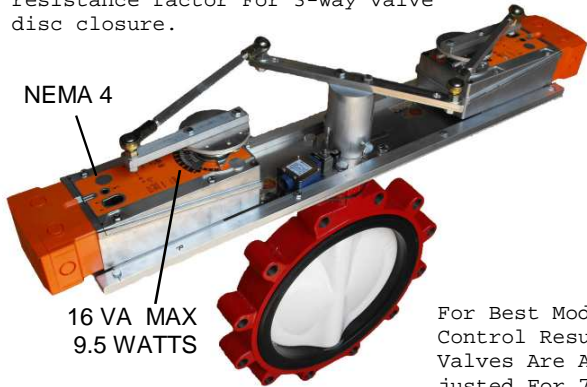

For Best Modulating Control Results Valves Are Adjusted For 70 Deg Max Opening

Ratings are Based on Bray S31-119 & Keystone AR2

Dual Spring Return Actuators For

STANDARD VALVE BODY FEATURES

- EPDM Rubber liner
- Stainless Steel or Nylon Coated Disc
- Stainless Steel Shaft
- Full Threaded Lug

SIZE	CV VALUES							
	144	84	61	43	27	16	7	1
2	144	84	61	43	27	16	7	1
2.5	282	163	107	67	43	24	11	1.5
3	461	267	154	96	61	35	15	2
4	841	496	274	171	109	62	27	3
5	1,376	775	428	268	170	98	43	5
6	1,850	1,025	567	354	225	129	56	6
8	3,316	1,862	1,081	680	421	241	102	12
10	5,430	2,948	1,710	1,076	667	382	162	19
12	8,077	4,393	2,563	1,594	1,005	555	235	27
14	10,538	5,939	3,384	2,149	1,320	756	299	34
16	13,966	7,867	4,483	2,847	1,749	1,001	397	45

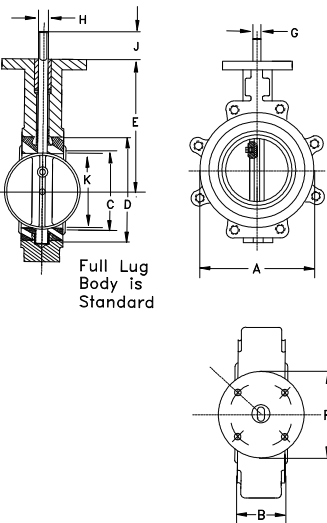

DIMENSIONS

SIZE	A	B	D	E	F	G	H	J	K
2"	3.69	1.62	2.84	5.50	3.54	.55	.39	1.25	1.32
2.5"	4.19	1.75	3.34	6.00	3.54	.55	.39	1.25	1.91
3"	4.88	1.75	4.03	6.25	3.54	.55	.39	1.25	2.55
4"	6.06	2.00	5.16	7.00	3.54	.63	.43	1.25	3.57
5"	7.12	2.12	6.16	7.50	3.54	.75	.51	1.25	4.63
6"	8.12	2.12	7.02	8.00	3.54	.75	.51	1.25	5.45
8"	10.50	2.50	9.47	9.50	5.91	.87	.63	1.25	7.45
10"	12.75	2.50	11.47	10.75	5.91	1.18	.87	2.00	9.53
12"	14.88	3.00	9.47	9.50	5.91	1.18	.87	2.00	11.47
14"	17.05	3.00	15.28	13.62	5.91	1.38	N/A	2.00	13.04
16"	19.21	4.00	17.41	14.75	5.91	1.38	N/A	2.00	14.85

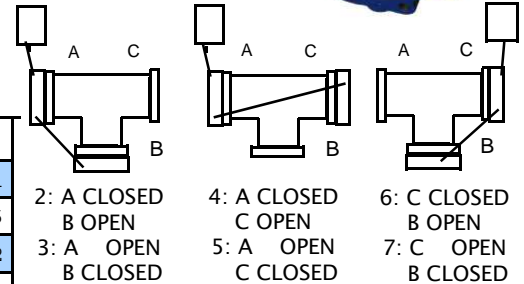

3-WAY VALVE ORIENTATIONS

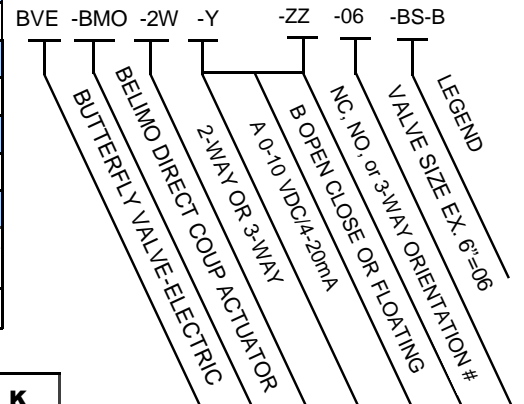

Part Numbering System

Legend

BS = Valve Bump Switch
B = Bray, K = Keystone
RF = Retrofit Kit



WESLEY VALVE CO.

MFGRS OF AUTOMATED BUTTERFLY VALVES
4938 S. Atlanta Rd., Ste. 100
Atlanta, GA 30339
PHN: (404) 351-8744
FAX: (404) 351-9340
www.wesleyvalve.com